

Product Catalogue & Price List

The 2020 Collection



dino
DECKING



Contents

- 4 Composite Decking Benefits
- 6 Dino Classic vs Dino Shield™ Comparison
- 8 Classic Range
 - Decking
 - Balustrades
 - Bullnose Edge
 - Skirting Board
 - Edging Trim
 - End Caps
- 20 Dino Shield™ Range
 - Decking
 - Bullnose Edge
 - Skirting Board
 - Edging Trim
 - End Caps
- 26 Fastening System
 - 6mm Fasteners
 - 3mm Fasteners
 - Starter Fasteners
- 32 Substructure
 - Composite Batten
 - Aluminium Joist
 - Pedestal
- 36 Composite Cladding - Dino Shield™ Range
- 38 Reviews & Comparison
- 42 Inspiration Gallery
- 50 Price List

ALAN TITCHMARSH LOVE YOUR GARDEN



Composite Decking Benefits

Durability

Composite decking is designed for maximum durability and won't crack, split or warp in the way that traditional timber deck boards do. Combining the strength of plastic with the look of wood, composite deck boards are stronger and denser than timber and are designed to withstand the elements while maintaining both looks and structure. Our lightweight composite deck boards have no splinters or rough edges, making them ideal for homes with bare feet and pets, and the weather-resistant construction helps to protect them from extremes of rain or snow and the sun's rays.



Low-maintenance



Composite decking is not only easy to install for both professionals and inexperienced homeowners, but requires minimal maintenance across its lifetime. The low maintenance decking retains its good looks without the regular upkeep required by timber deck boards. Wooden decking must be sanded, sealed and stained regularly to maintain a perfect finish, and board replacements may also be necessary over time. Composite decking, however, does not require the same time-consuming and expensive regular maintenance. Designed to maintain its shape and colour, an occasional wash with soapy water is often the only maintenance required to preserve the beauty of our composite deck boards.



Aesthetics

Offering all the natural beauty of timber in a stronger and more practical form, composite deck boards are manufactured with an authentic wood grain pattern to enhance any outside area. The decking's hidden fastener system keeps the finished deck surface flawless, and offers a clean, uniform look. Our composite deck boards are supplied with a reversible design, featuring attractive wood grain on one side and textured ridges on the other. Available in a range of traditional and contemporary colours, the board patterns and tones can be combined and contrasted to highlight deck edges for an elegant, modern finish.



Savanna



Sustainability

An environmentally friendly alternative to the use of traditional timber for deck boards, our composite decking is manufactured using a combination of 55% recycled wood and 40% recycled HDPE plastic along with 5% additives (colour, bonding agent etc.).

Utilising recycled wood fibres in the deck boards is more sustainable than chopping down trees for fresh timber, while recycling plastic prevents the synthetic waste being sent to landfill sites. Conserving natural resources and re-purposing plastic waste, choosing the eco-friendly composite alternative to timber minimises the environmental impact of any decking project.

Value

The strength and durability of our composite boards result in a deck with a significantly longer lifespan than could be expected from traditional timber decking. Composite decking's low maintenance design doesn't require regular sanding, sealing, treating or board replacements, meaning annual upkeep costs are low to non-existent, saving money every year.

While the initial investment to purchase composite decking may be slightly higher than timber, the longevity and low maintenance design of the composite boards offer an improved return on investment over the lifespan of your deck.



Anthracite

Decking Range Comparison

Classic Range

Our Classic Composite Decking range is durable, low maintenance and environmentally friendly, and will not split, crack, rot or warp like timber. This cost-effective uncapped composite decking has a hollow, lightweight design and the reversible planks feature natural wood grain and ridged finishes in a choice of 8 traditional and modern colours.



Comparison Table

While both our Classic and Premium decking ranges offer impressive durability, easy installation and minimal maintenance requirements, the Premium range provides additional weather protection for a slightly increased initial investment, while the Classic range combines quality and affordability. Compare the differences between the two ranges below.

	Classic Range	Premium Range
Price	★★★★★	★★★★☆
Weather Resistant	★★★★☆	★★★★★
Mould Resistant	★★★★☆	★★★★★
UV Resistant	★★★★☆	★★★★★
Splinter Resistant	★★★★★	★★★★★
Slip Resistant	★★★★☆	★★★★★
Lifespan	★★★★☆	★★★★★
Aesthetics	★★★★☆	★★★★★

Premium Range

Even tougher, more resilient and longer lasting than the Classic range, our Premium Composite Decking is finished with Dino Shield™ protection for the ultimate in weather resistance and mould and mildew prevention. With improved stain, scratch and colour fade resistance, our capped deck boards deliver the highest quality decking available in a choice of 3 classic colours with a reversible wood grain and grooved finish.

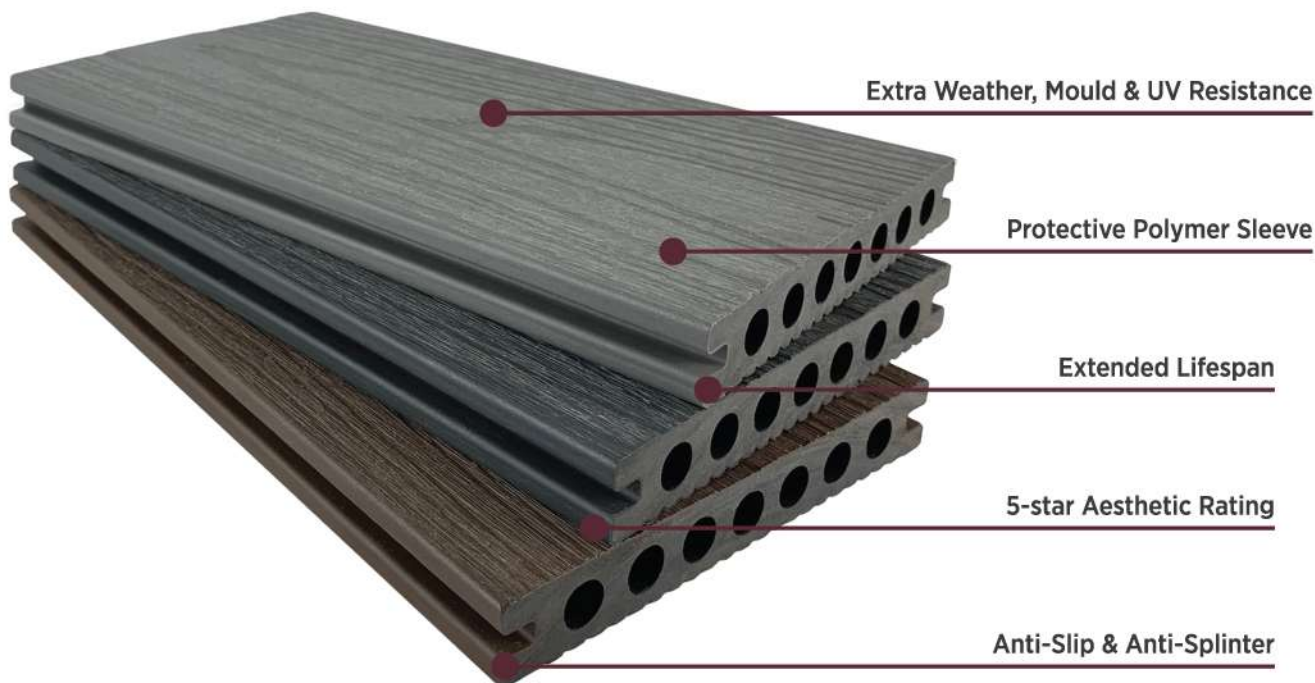

Dino Shield™ Technology

Creating a protective shell bonded around all four sides of the deck board, Dino Shield™ is a polymer sleeve that provides outstanding moisture resistance. Offering the thickest layer of protection available on the UK market, Dino Shield™ deck boards have a longer lifespan due to decreased water absorption. The polymer coating provides increased stain, algae and mould resistance along with added UV protection to reduce colour fade.



When selecting suitable composite decking products, design taste, deck location and available budget are all important factors. For high footfall areas, locations exposed to extreme weather or customers requiring the highest quality finish, investing in Premium Composite Decking will deliver the ultimate long-lasting pristine finish, while the Classic range provides a reliable and cost-effective alternative.

Both our Classic and Premium ranges deliver durability and performance, creating stunning decks that will last for decades, and each is supplied with a 10 year warranty.

Composite Decking Classic Range

£19.99 per 4m Length Inc VAT

£11.99 per 2.4m Length Inc VAT

£34.39 per m² Inc VAT

*Please note Stone coloured decking boards
are 12.5% more expensive.

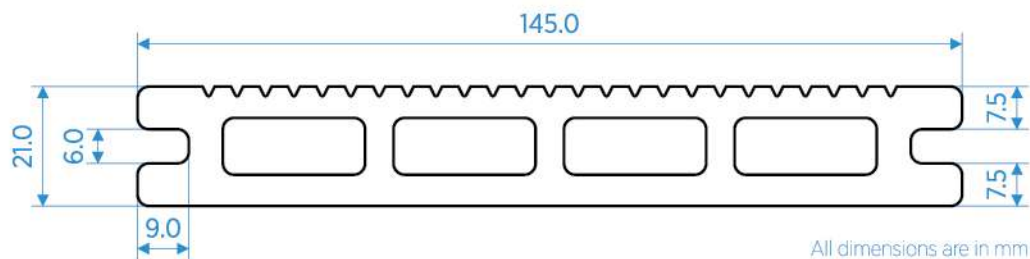

All dimensions are in mm



Ash

Our durable, reversible non-slip decking boards are available in a choice of 8 modern and natural colours, each with a contemporary grooved finish on one side and beautiful natural wood texture on the other. The eco-friendly recycled wood and plastic decking boards offer improved protection against stains when compared to timber, and are weather-resistant and lower maintenance than traditional timber decking which may warp, crack, splinter or require annual sanding, staining or sealing. Fixed in position with an invisible fastening system for a clean and professional finish, the composite decking boards come with a 10 year warranty.



Savanna



Amber



Cedar



Mocha



Silver



Stone

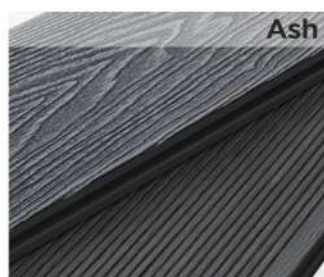

Ash

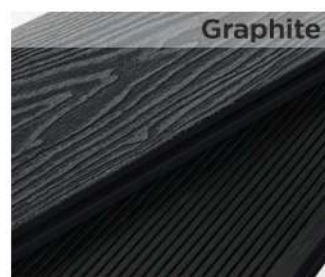

Graphite

- Eco-friendly recycled wood and plastic Composite Decking Boards
- Reversible design – grooved finish on one side, wood texture on the other
- 8 available colours: Savanna, Amber, Cedar, Mocha, Silver, Stone, Ash, Graphite
- Short boards measure 2400mm (L) x 145mm (W) x 21mm (D)
- Standard boards measure 4000mm (L) x 145mm (W) x 21mm (D)
- 10 year warranty

Composite Decking Balustrade

Classic Range

£49.99 per post Inc VAT

£49.99 per 1.2m railing kit Inc VAT



Ash & Silver

Frame your composite decking with an elegant balustrade to create an enclosed garden terrace. A safe and practical finishing touch for raised deck areas, the balustrade comprises strong metal posts with composite sleeves connected by composite railings with 5cm spindles.

Available in a choice of 8 modern and natural colours to complement or contrast with your composite decking, the balustrades are made of eco-friendly recycled wood and plastic which won't splinter or crack like traditional timber, making them ideal handrails.

Each balustrade post includes: 1 metal support post, 1 composite post sleeve, 1 foot cover, 1 composite post cap, and 4 M10 bolts to connect the post to the joist. Each railing kit includes: 9 spindles, 1 handrail, 1 bottom rail, 2 small support pieces and all fixings.

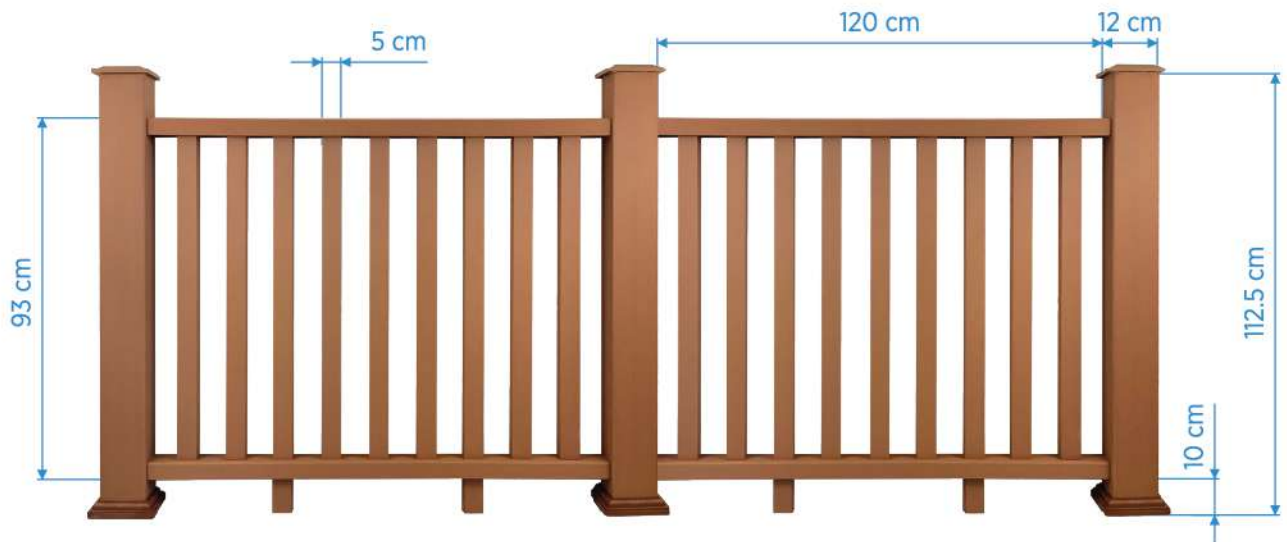

- Eco-friendly recycled wood and plastic Composite Balustrades
- Strong metal posts with composite sleeves
- 8 available colours: Savanna, Amber, Cedar, Mocha, Silver, Stone, Ash, Graphite
- Balustrade railings measure 1200mm (W) x 930mm (H) with 50mm spindles
- Balustrade posts measure 1125mm (H) x 120mm (W)
- 10 year warranty

Composite
Balustrade

Bullnose Edge

Classic Range

£14.99 per 2.2m Length Inc VAT

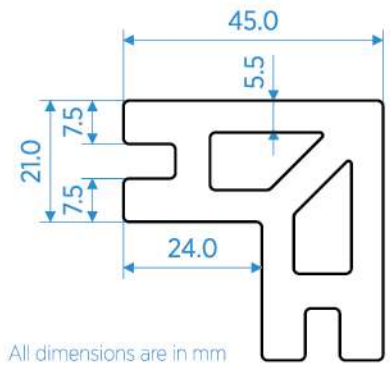

Savanna

For a perfectly flawless, flush finish to your steps and rough deck edges, our Bullnose Edge has the same profile and thickness as our Composite Decking Boards and is supplied with an attractive sanded finish. The low maintenance, environmentally friendly recycled wood and plastic Bullnose Edges are easy to install with the same 3mm or 6mm hidden fasteners as the deck boards, connecting down to a decking board being used to cover the exposed side. Complementing deck boards presented either grooved side or wood grain side up, select the same colour as your deck boards or highlight deck edges with a contrasting tone for a stylish and contemporary finish.



Cedar



Bullnose
Edge

- **Eco-friendly** recycled wood and plastic Bullnose Edge
- **Low maintenance** – will not rot, warp or splinter
- **8 available colours:** Savanna, Amber, Cedar, Mocha, Silver, Stone, Ash, Graphite
- Measures 21mm thick, 2200mm length
- Outer dimensions 45mm x 45mm, inner 24mm x 24mm
- **Attractive sanded finish**
- Attaches with **hidden fastener system**

Skirting Board

Classic Range

£9.99 per 2.2m Length Inc VAT

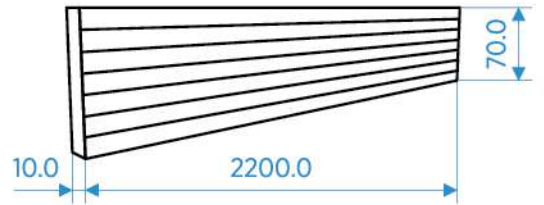

All dimensions are in mm

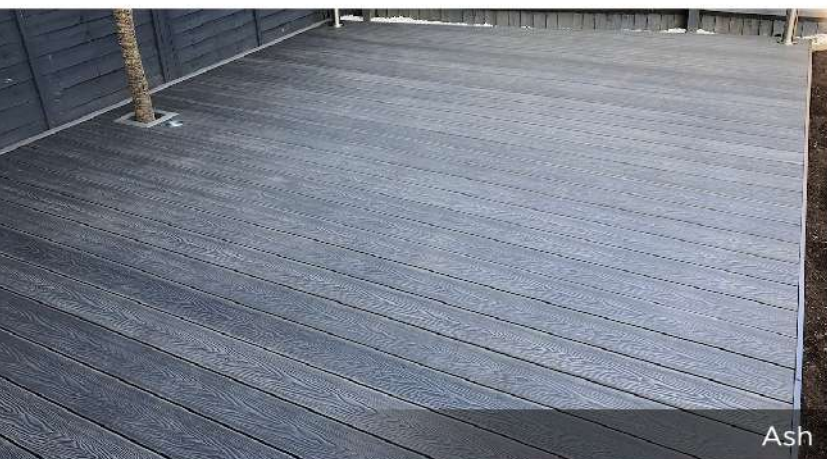
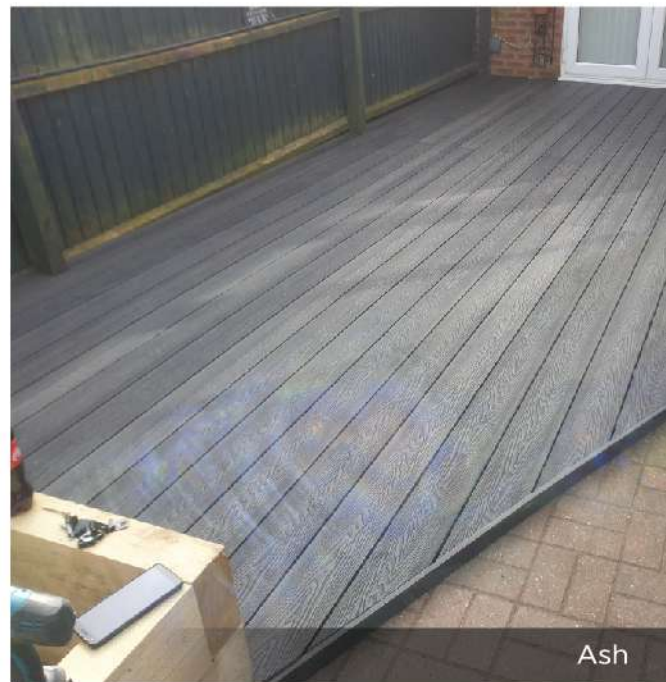

Offering the perfect finish to your decking, our Skirting Board effectively covers open vertical spaces and can be used to finish any exposed sides. At 70mm wide these work perfectly with the height of our Composite Joist and Decking Boards together.

Our reversible Skirting Board features a grooved finish on one side and a wood grain effect to match our decking boards on the other. The low maintenance, environmentally friendly recycled wood and plastic material won't require regular sanding, painting or staining.

Easy to install, skirting boards can be predrilled and screwed through or for a seamless finish they can be attached with an outdoor grab adhesive.

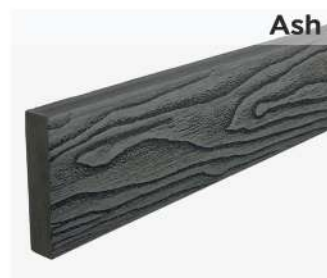

Skirting Board

- **Eco-friendly** recycled wood and plastic Skirting Board
- **Low maintenance** – will not rot, warp or splinter
- **8 available colours:** Savanna, Amber, Cedar, Mocha, Silver, Stone, Ash, Graphite
- Measures 2200mm (L) x 10mm (W) x 70mm (H)
- **Reversible design** with grooved finish or wood grain effect
- Attach with **screws** or **outdoor adhesive**

Edging Trim

Classic Range

£7.99 per 2.2m Length Inc VAT

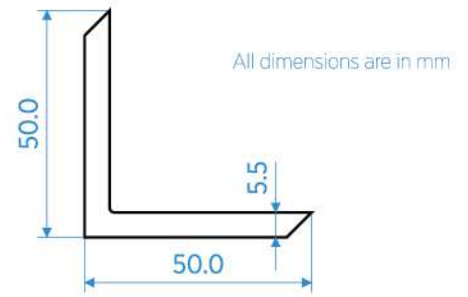

Ash

Add clean corners and professional edges to your composite decking project with our coordinating Edge Trim. Perfectly finishing any rough deck edges, the trim sits over the edge of the deck, covering corners and concealing joints where horizontal deck boards meet vertical fascia boards, hollow board ends or the groove down the side of the decking.

The L-shaped Edge Trims have a bevelled edge to prevent trips and falls and an attractive sanded finish to complement our Composite Deck Boards. Easy to install, the Edge Trims can be predrilled and screwed through, or for a flawless finish, they can be securely attached with outdoor adhesive.

Edging Trims are a lower cost alternative to Bullnose Edging but leave a slight lip over the decking. For a more premium, flush finish, choose Bullnose Edging.



Stone



Savanna

Amber

Cedar

Mocha

Silver

Stone

Ash

Graphite

Edging
Trim

- **Eco-friendly** recycled wood and plastic Edge Trim
- **Low maintenance** – will not rot, warp or splinter
- **8 available colours:** Savanna, Amber, Cedar, Mocha, Silver, Stone, Ash, Graphite
- Measures 2200mm (L) x 50mm (W) x 50mm (H)
- Sanded finish with a **bevelled edge**
- Attach with **screws** or **outdoor adhesive**

End Caps

Classic Range

£0.72 per piece Inc VAT

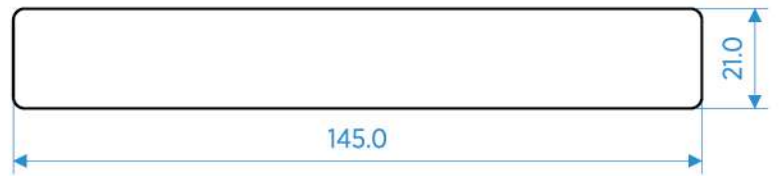

All dimensions are in mm



Ash

Professionally finish your decking by concealing open deck board hollow ends with our easy to install push-fit End Caps. A simple and effective way to conceal exposed areas and protect decking from the elements, the optional composite End Caps have a push-fit design for a seamless, flawless finish.

Manufactured from the same low maintenance, environmentally friendly recycled wood and plastic material as our Composite Decking Boards, the End Caps are available in all 8 colours and retain their beauty without requiring regular sanding, painting or staining.

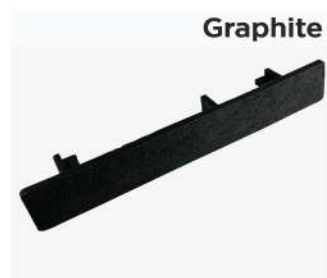

End Caps

- **Eco-friendly** recycled wood and plastic End Cap
- **Low maintenance** – will not rot, warp or splinter
- **8 available colours:** Savanna, Amber, Cedar, Mocha, Silver, Stone, Ash, Graphite
- **Simple push-fit design**

Composite Decking

Premium Range

£29.99 per 4m Length Inc VAT
£17.99 per 2.4m Length Inc VAT
£51.59 per m² Inc VAT

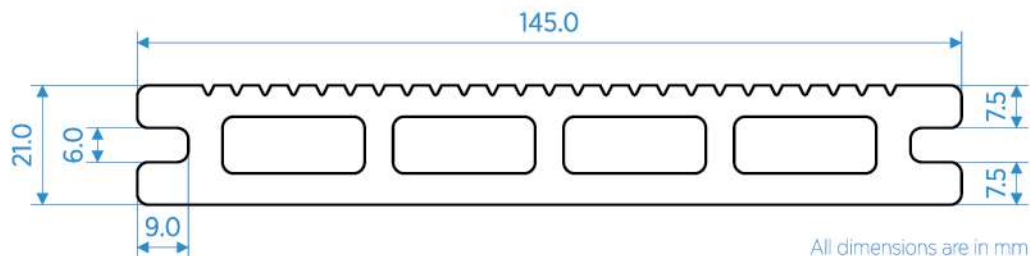

All dimensions are in mm



Pearl

Finished with a tough, water-resistant Dino Shield™ polymer sleeve, our Premium Capped Composite Decking Boards offer the thickest capped decking shell available in the UK for outstanding stain and weather resistance while maintaining the natural aesthetics of timber.

Made from the same eco-friendly recycled wood and plastic composite as our Classic Composite Decking, the Premium Composite Deck Boards are ultra-low maintenance and will not warp, split, crack or splinter. This capped composite decking also features improved stain resistance, mould resistance and minimal colour fade over time, keeping your decking looking pristine for longer with practically zero maintenance – just wipe clean as needed.



Our reversible non-slip deck boards are fixed in place with a hidden fastener system, and are available in a choice of 3 colours, each with a grooved side and beautiful natural wood textured side. Supplied with a 10 year warranty.

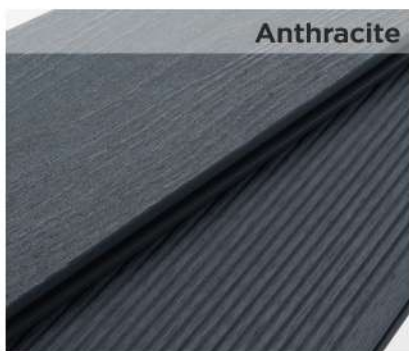

- **Eco-friendly** recycled wood and plastic capped Composite Decking Boards
- **Dino Shield™** polymer sleeve for stain, fade, scratch and mould resistance
- **Reversible design** - grooved finish on one side, wood texture on the other
- Short boards measure 2400mm (L) x 145mm (W) x 21mm (D)
- Standard boards measure 4000mm (L) x 145mm (W) x 21mm (D)
- **10 year** warranty

Bullnose Edge Premium Range

£16.99 per 2.2m Length Inc VAT

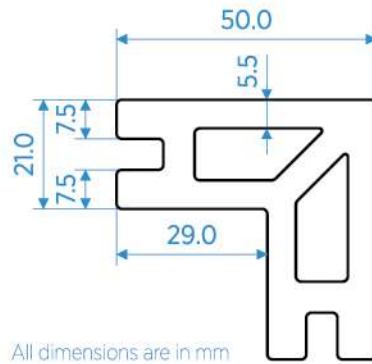

Professionally finish your deck edges and keep them looking flawless for longer with our Premium Capped Bullnose Edge. Made from the same low maintenance, environmentally friendly recycled wood and plastic material as our composite decking, the Premium Bullnose Edge has the same profile and thickness as our deck boards to create a perfectly flush finish over rough deck edges.



Pearl



Anthracite

Capped with our hardwearing, moisture resistant Dino Shield™ polymer sleeve, the Bullnose Edge is more stain resistant, mould resistant and fade resistant than uncapped composite edges, and won't rot, warp, crack or split – no sanding or treating required.



Walnut

Easy to install with hidden fasteners, the Bullnose Edge is available in 3 colours and is practically zero maintenance – just wipe clean as needed.

- **Eco-friendly** recycled wood and plastic Capped Bullnose Edge
- **Dino Shield™** polymer sleeve for stain, fade and mould resistance
- **Low maintenance** – will not rot, warp or splinter
- Measures 21mm thick, 2200mm length
- Outer dimensions 50mm x 50mm, inner 29mm x 29mm
- Attractive **sanded finish**
- Attaches with **hidden fastener system**

Skirting Board

Premium Range

£10.99 per 2.2m Length Inc VAT

Offering the perfect finish to your decking, our Skirting Board effectively covers open vertical spaces and can be used to finish any exposed sides. At 70mm wide these work perfectly with the height of our Composite Joist and Decking Boards together.



Pearl



Anthracite

Protected by our moisture resistant Dino Shield™ polymer sleeve, our Premium Skirting Board is manufactured from the same low maintenance, environmentally friendly recycled wood and plastic material as our Classic Composite Decking Boards, and has a reversible design with a simple grooved finish on one side and a wood grain effect on the other. Capped with the thickest protective shell available in the UK, the Skirting Board will not warp, crack or split, and offers improved stain, mould and scratch resistance. The board is practically maintenance-free – simply wipe as needed to keep vertical surfaces looking pristine.

Designed for quick and easy installation, the 2200mm x 10mm x 70mm fascia lengths can be screwed through or attached into position with outdoor adhesive for a flawless finish.

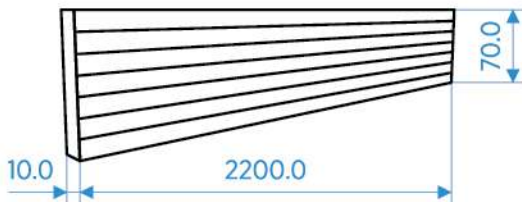

All dimensions are in mm



Walnut



- **Eco-friendly** recycled wood and plastic Premium Skirting Board
- **Dino Shield™** polymer sleeve for stain, fade, scratch and mould resistance
- **Low maintenance** – will not rot, warp or splinter
- Measures 2200mm (L) x 10mm (W) x 70mm (H)
- **Reversible design** with grooved finish or wood grain effect
- Attach with **screws** or **outdoor adhesive**

Edging Trim Premium Range

£8.99 per 2.2m Length Inc VAT

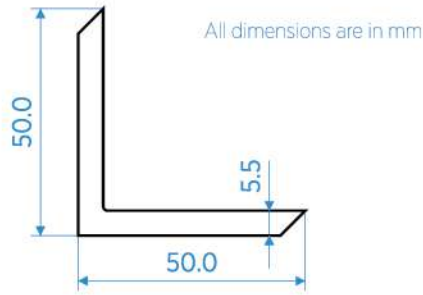

Premium Edge Trim is an attractive and efficient way to create professional edges and clean corners to your decking, sitting neatly over the edge of the deck.



Pearl

A perfect finishing touch to any high-end decking project. Our Capped Edge Trims cover edges and conceal joins where horizontal deck boards meet vertical deck boards. Edging Trims are a lower cost alternative to Bullnose Edging but leave a slight lip over the decking. For a more premium, flush finish, choose Bullnose Edging.



Anthracite

With an attractive sanded finish and bevelled edge for safety, the L-shaped Premium Edge Trims are easy to install by screwing through or can be attached with outdoor adhesive to keep your deck surface fastener-free and flawless.



Walnut

- **Eco-friendly** recycled wood and plastic Premium Edge Trim
- **Dino Shield™** polymer sleeve for stain, fade, scratch and mould resistance
- **Low maintenance** – will not rot, warp or splinter
- Measures 2200mm (L) x 50mm (W) x 50mm (H)
- **Sanded finish** with bevelled edge
- Attach with **screws** or **outdoor adhesive**

End Caps

Premium Range

£0.99 per piece Inc VAT

For a professional finish to your Premium Decking, our easy to install End Caps conceal open deck board edges and protect your decked areas from the elements.

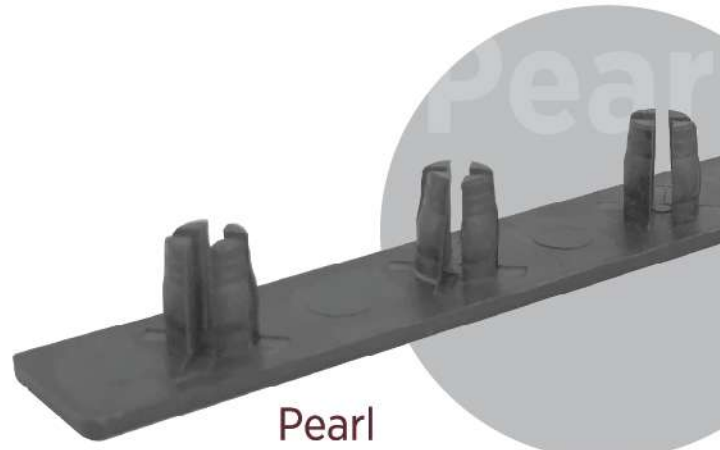

Pearl

Simply pushing into place in a matter of seconds with no screws, fixings or fasteners required, our Premium End Caps are a fast, effective and simple way to conceal unsightly exposed areas. Made of 100% PE plastic, the End Caps offer strength and durability over time to keep your decking looking pristine.



Anthracite

Offering a seamless, flawless finish to enhance your decking project, the optional End Caps are colour matched to perfectly complement the 3 colours available in the Premium Composite Decking range.



Walnut

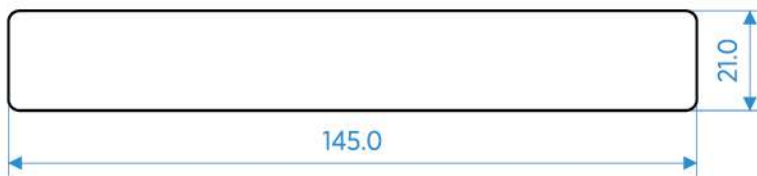

All dimensions are in mm

- Durable PE plastic Premium End Cap
- Low maintenance – strong and durable
- 3 available colours to match the Premium Decking range
- Simple push-fit design

6mm Hidden Fasteners Fastening System

£19.99 per bag of 100 with screws Inc VAT

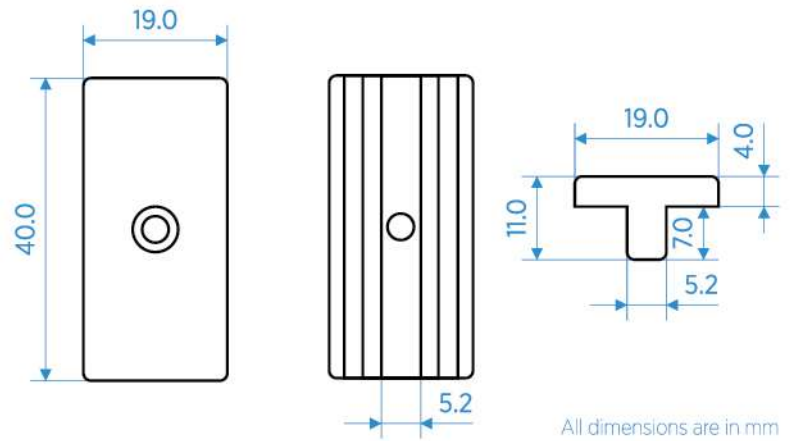

For fast, efficient and secure installation with no visible nails or screws, our 6mm Composite Decking Fasteners are a reliable and affordable option. The plastic T-fasteners securely attach deck boards to their frame, while reducing installation time and keeping costs low.

Attaching to the side of the deck boards, the concealed fixings are barely visible once secured in position and establish a uniform 6mm space between each decking board for a neat and professional-looking finish.

These affordable 6mm Composite Decking Fasteners are ideal for cost-effective deck installations.

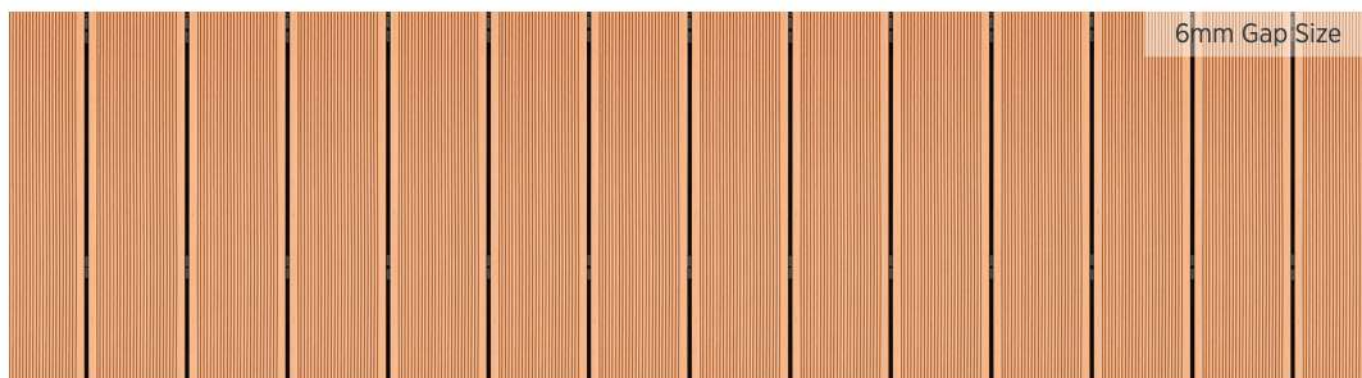
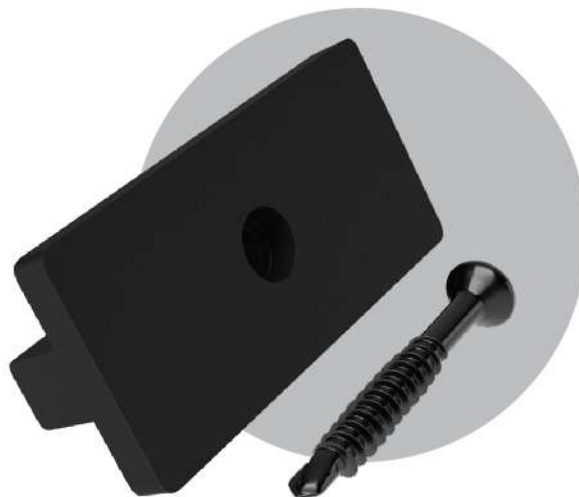

- Bag of 100 hidden 6mm Composite Decking Fasteners
- Ensures uniform 6mm gaps between boards
- No visible fasteners - seamless deck finish
- Plastic T-fastener
- Stainless steel screws covered in black zinc coating with TORX-15 screw head



Our cost-effective plastic 6mm Composite Decking Fasteners are each supplied with a self-drilling screw. Requiring no pre-drilled holes, the self-drilling design makes installation quicker and easier, and the screws are partially threaded, with ridges down the bottom of the shank and an unthreaded shaft directly below the head. Designed for improved force and alignment, the partially threaded screw slides through the fastener and uses compression as well as thread friction to hold the clip and board tightly together.

Delivering strength, resistance and easy alignment, the fastener screws are supplied in black to coordinate with the decking fasteners.

Offering the most pristine finish with the smallest gaps between boards, our hidden 3mm Composite Decking Fasteners closely align deck boards with no visible fixings. Securely attaching your decking boards to their frame, the fasteners maintain a consistent minimal gap between boards for the ultimate neat and professional-looking finish, and the narrow gap left by the fasteners also conceals the joists from view while still allowing efficient drainage.

Made of weather-resistant stainless steel to prevent rust, each fastener is also black zinc coated for extra protection and reduced visibility and comes supplied with a durable weatherproof large head screw.

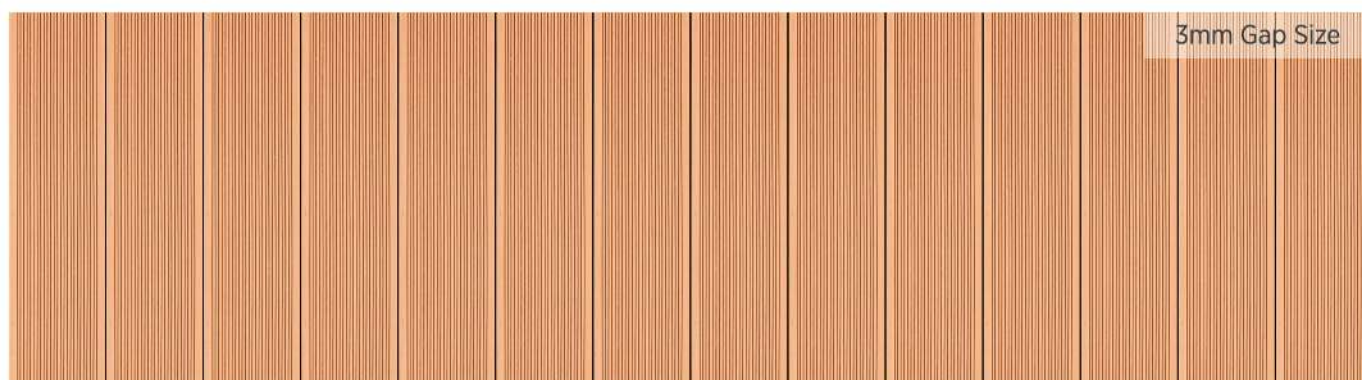

- Bag of 100 hidden 3mm Composite Decking Fasteners
- Ensures uniform 3mm gaps between boards
- No visible fasteners - seamless deck finish
- Large head self-drilling screw supplied with each fastener
- Weatherproof, rust-resistant stainless steel with black zinc coating
- Stainless steel screws covered in black zinc coating with TORX-15 screw head



Each of our premium 3mm Composite Decking Fasteners is supplied with a fully threaded, large head self-drilling screw. Designed with a pointed tip to create its own pilot hole in the joist, the threaded screw eliminates the need for pre-drilled holes and effortlessly bores into the joist while tapping and fastening at the same time.

The large head offers greater resistance to penetration into the joist, and the weatherproof stainless steel screw has a black zinc coating that coordinates with the fastener and provides additional durability.

Starter Hidden Fasteners Fastening System

£26.99 per 100 pieces Inc VAT

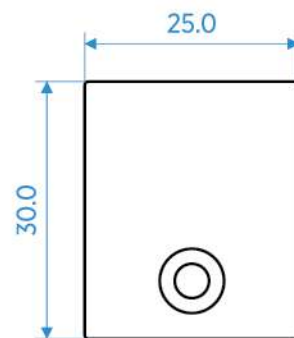
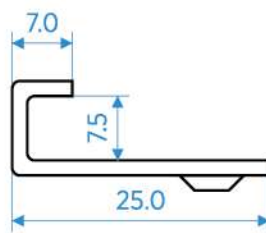

All dimensions are in mm



30

Ensuring perfect placement and alignment, the Starter Fasteners act as a starting point, while quickly and reliably attaching the first board of a decking section to the frame beneath. The one-way fastener is an essential composite decking accessory to get the first row started or to hold the last row in alignment, as the single sided design will not extend out from the decking or cause issues when attaching fascia panels.

As part of our hidden fastener system, the Starter Fasteners are designed to remain concealed from sight to ensure your decking has a seamless finish with no visible screws or fixings. As well as being aesthetically pleasing, the hidden fastener system's lack of exposed fixings is preferable for decks used by children, pets and bare feet.

Delivering a neat and tidy finish, the Starter Fasteners are made from durable weatherproof, rust-resistant stainless steel with back zinc coating for extra protection and reduced visibility. The fasteners are quick and straightforward to use, reducing time spent aligning and fitting those crucial initial deck boards.



- Bag of 100 Starter Fasteners
- One-way fastener for first and last deck boards
- No visible fasteners - seamless deck finish
- Self-drilling screw supplied with each fastener
- Weatherproof, rust-resistant stainless steel with black zinc coating
- Stainless steel screws covered in black zinc coating with TORX-15 screw head



Starter Fasteners are each supplied with a fully threaded self-drilling screw for a secure fit. No pre-drilling is required as the screw bores, taps and fastens in one easy action for a strong and precise hold. The fully threaded screw shank is designed for exceptional grip and is ideal for use with composite materials.

Made of rust resistant stainless steel, the weatherproof screws are finished with a black zinc coating for improved longevity and to make the clips as unobtrusive as possible, coordinating perfectly with the Starter Fasteners themselves.

Composite Batten

Substructure

£7.99 per 3m Length Inc VAT

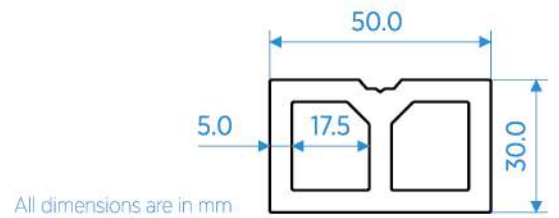

Provide weatherproof, low maintenance, hardwearing support for your decking by creating a subframe with our Low Profile Composite Battens.

Designed to be used either way up and suitable for use on a solid weight-bearing base such as concrete, the strong, lightweight Composite Battens prevent rotting, warping, splintering and splitting, and won't require the treatment or replacement necessary for timber joists. Our Low Profile Composite Battens are not suitable for raised decking projects - we recommend using pedestals and aluminium joists instead.



- Hollow, lightweight Low Profile Composite Battens
- Reversible 30mm x 50mm x 3000mm (L)
- Weather-resistant, hardwearing decking support
- Low maintenance - will not rot, warp or splinter
- Not suitable for use with raised decks



Aluminium Joist Substructure

£19.99 per 3.6m Length Inc VAT

Strong, durable and lightweight, our corrosion resistant Aluminium Joists offer reliable and long-lasting support for any decking project. Designed to create a solid substructure with rapid installation, the lightweight aluminium joists only require a pedestal support every 1.2m, saving both time and money.

Made from high quality T6 aluminium, the joists have a powder coated finish for additional protection against the elements. Securing into position easily when fitted using our fasteners which are supplied with self-drilling screws, the Aluminium Joists are black in colour as they will remain hidden from view, and are ideal for creating raised deck areas.

- Lightweight Aluminium Joists
- Corrosion-resistant powder-coated T6 aluminium
- Rapid installation with supporting pedestals
- 75mm (H) x 40mm (W) x 3600mm (L)
- Ideal for supporting raised decks

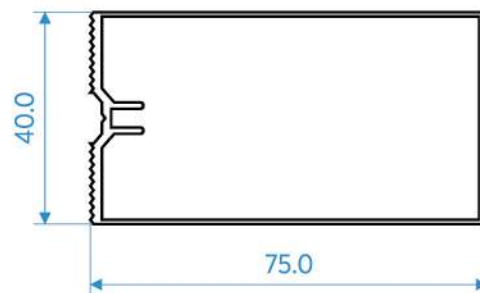

All dimensions are in mm

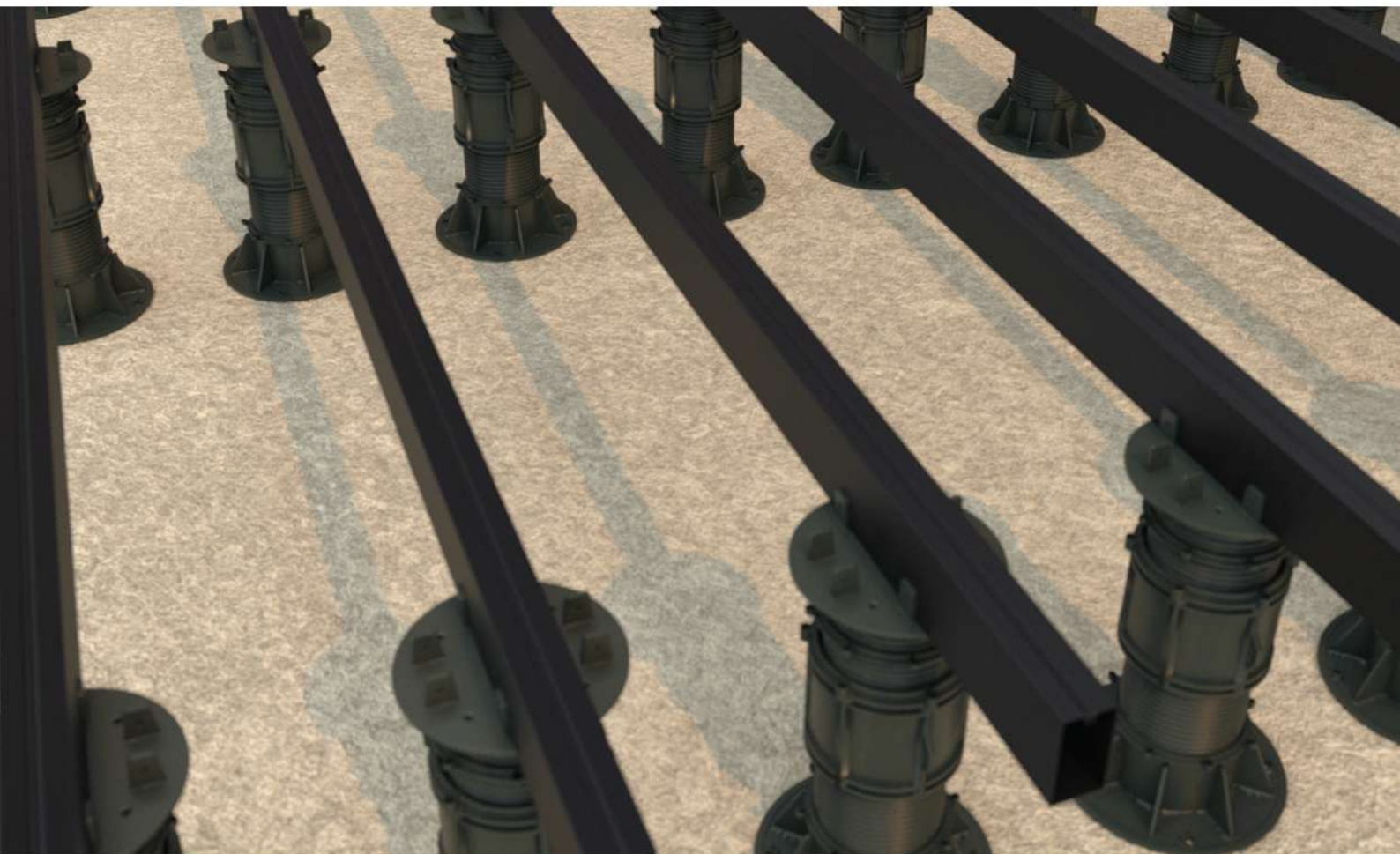

Pedestals

Substructure

Price depends on size of pedestal. Please see price list on page 51.

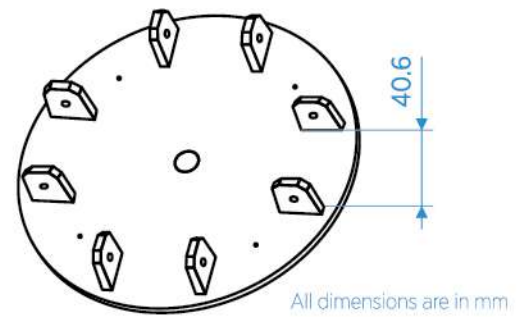

Raise the level of your deck quickly and easily, while also preventing rot with our robust Adjustable Pedestal Supports.

Strong and sturdy with a broad base, the polypropylene supports effortlessly increase the height of your deck and feature simple joist cradles on top for fastening joists into position. Available in 10 sizes, each designed to tolerate 1000kg in weight, our range features Adjustable Pedestal Supports offering variable heights from 15mm to 528mm – just choose the correct pedestal size and rotate the stem to adjust the joist frame level.



Raising the substructure above ground level, the Adjustable Pedestal Supports effortlessly lift the joists into the required position. A fast and straightforward way to create a level deck frame with even weight distribution, the raised joist system also provides practical space beneath the deck structure which can be used for neatly concealing pipework, cables and drainage services.

The Adjustable Pedestal Supports are suitable for use with aluminium joists (not recommended for use with composite joists).

- Robust Adjustable Pedestal Supports
- 15mm - 528mm adjustable height range
- Easy to use integral joist cradle
- 1000kg weight bearing
- Suitable for use with timber or aluminium joists
- Optional 65mm timber cradle - please request

Quickly and effectively adjusting the angle of any of our pedestals by up to 5 degrees, our Slope Correctors can be rotated for precise angle correction and are ideal for tilt prevention on ground with a slight incline.



Suitable for use with every size of pedestal support, our Rubber Mat can be fitted underneath the pedestal to protect any underlying membrane or material, and has the added benefit of effective sound absorption.



Composite Cladding Premium Range

£19.99 per 4m Length Inc VAT
£34.39 per m² Inc VAT

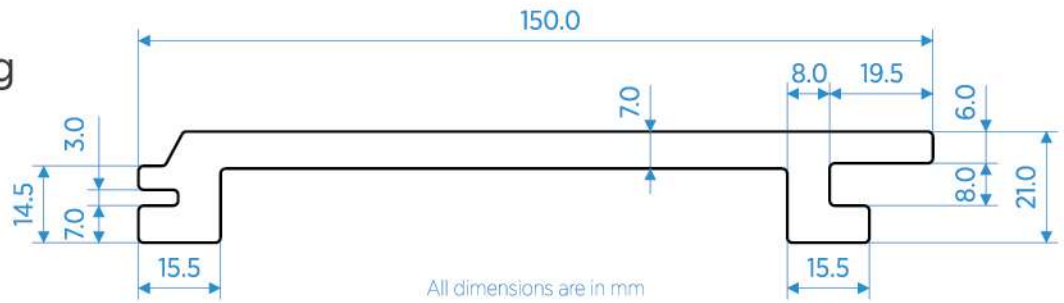

Anthracite

Enhance your outdoor areas with our decorative Composite Cladding, which is quick and easy to install with hidden fasteners and requires practically zero maintenance once in place.

Made from an eco-friendly recycled timber and plastic composite, the durable cladding is then encased in a water resistant Dino Shield™ polymer sleeve, which offers the thickest protective shell available in the UK.

Designed not to warp, rot or split, the Capped Composite Cladding is more stain resistant, scratch resistant and mould resistant than uncapped composite materials and the polymer coating is also UV resistant to minimise colour fade over time.



Fire rated class B, the Composite Cladding is suitable for hotels and office buildings of any height, and any building under 18m including residential dwellings. Each cladding board measures 21mm x 145mm x 4000mm (4m) and is finished with a light wood grain pattern, colour matched to complement our Premium Composite Decking Boards.



Pearl



Anthracite



Walnut

- **Eco-friendly** recycled wood and plastic Premium Composite Cladding
- **Dino Shield™** polymer sleeve for stain, fade, scratch and mould resistance
- **Low maintenance** - will not rot, warp or splinter
- Light wood grain finish **available in 3 colours**
- Attaches with **hidden fastener system**
- Fire rated **class B**
- Measures 21mm (W) x 145mm (H) x 4000mm (L)

At Dino Decking, our goal is to offer high quality composite decking to customers across the United Kingdom, without compromising on price. In fact, we believe our cost-effective decking products are superior to the current competitive range on the market. We pride ourselves on our strong reputation, and encourage all our customers to leave a review of our products and service. We currently collect reviews on the largest reviews site, Trustpilot, where a large majority of reviews rate us at 5 stars. We are rated 4.8/5 and have collected over 250 reviews. Other customers have shared their experience of dealing with us by leaving reviews on Google, Yell and Reviews.co.uk – a selection of recent reviews are featured below.

*As of 8th May 2020

Very pleased with Dino Decking. I took my design when I visited their centre in Wigan and they helped me with ideas to improve the build. Prices are very competitive. I needed an earlier than normal slot and was accommodated, and all items were delivered on time. The build is almost complete and has no issues with parts or quality of the products. Highly recommend these guys, they keep it simple.

Tony Hawkins



Savanna

Great customer service from the very beginning when I asked for a sample box, right through to the day of my order delivery. The product itself is just what I wanted in terms of look, strength and longevity and is easy to work with; it looks great in place and has attracted many complimentary comments. Would not hesitate to recommend this product for all these reasons, but also its very competitive pricing.

Martijn Grover



Graphite

Really impressed with this product and company. I had a 25m2 area that was in need of a new look. Ordered the 4m length boards which are all exactly the same length, some others don't offer this. Dino Decking support team were great at answering questions throughout the process, and delivery was as promised. The decking itself is based on a very easy to install system - I highly recommend the composite joists. I used the 3mm fasteners which work really well and give a very nice look.

Matt Magill



“ Brilliant company.
Reliable and do exactly what they say.
So refreshing.
A lot of companies could learn from them. ”

Paul Mayer



Anthracite

Company Comparison

Choosing the Right Composite Decking Supplier

Adding a composite deck to your residential or commercial property is a great investment, and as composite decking has grown in popularity, so has the number of companies supplying the materials required.

While it may seem that each of these suppliers offers broadly the same products and services, it is important to compare them closely in order to ensure your deck is the most beautifully finished, durable and cost-effective option available.

At Dino Decking we are committed to providing the best composite decking materials at the best prices with the best customer service, and are happy to be compared to our closest competitors.

	 Live.Life.Outside.				
Price per linear meter (Uncapped)	£14.46	£4.99	£5.94	£7.47	N/A
Price per linear meter (Capped)	N/A	£7.49	N/A	£10.68	£7.92
Number of colours	10+	10+	8	9	10+
Delivery timescale	N/A	1-5 Working Days	<10 Working Days	3-5 Working Days	N/A
UK based company	Yes	Yes	Yes	Yes	No
Online reviews (Trustpilot)	No Reviews	4.8/5.0	4.5/5.0	4.5/5.0	No Reviews

Pricing & Offering

Dino Decking offers a choice of both Classic Uncapped Composite Decking and Premium Capped Composite Decking featuring Dino Shield™, the thickest polymer sleeve available on the UK market. With a wide range of colours, we also offer the lowest price per linear metre when compared to the other market-leading companies, ensuring outstanding value for money.

Delivery

We understand the need for fast and efficient delivery of your decking order and use reliable postage and courier services to ensure your materials reach you as quickly as possible. Small orders will be delivered within 1-2 days, while larger orders containing decking boards will be scheduled for complete delivery within 5 working days wherever possible.

Reputation

At Dino Decking we are proud to supply the highest quality composite decking products across the UK from our UK based premises. Along with premium supplies, we take our customer service extremely seriously and pride ourselves on our thousands of happy customers. Don't just take our word for it – our Trustpilot rating is 4.8/5.



Silver



Savanna



Savanna

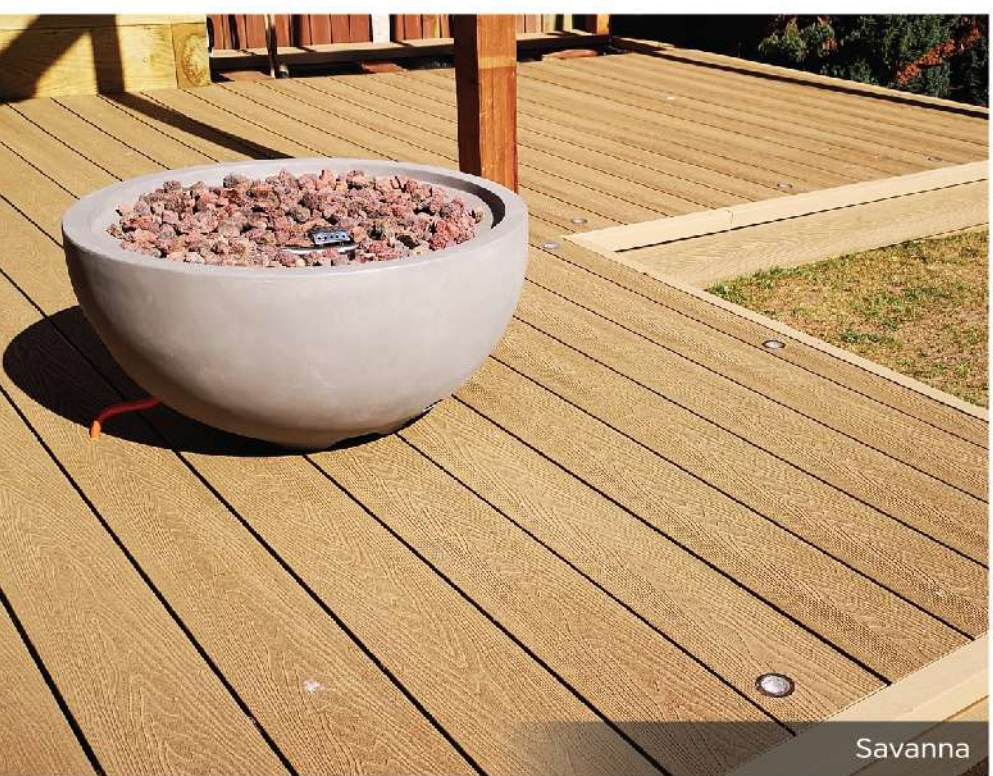

Savanna



Silver & Graphite



Ash

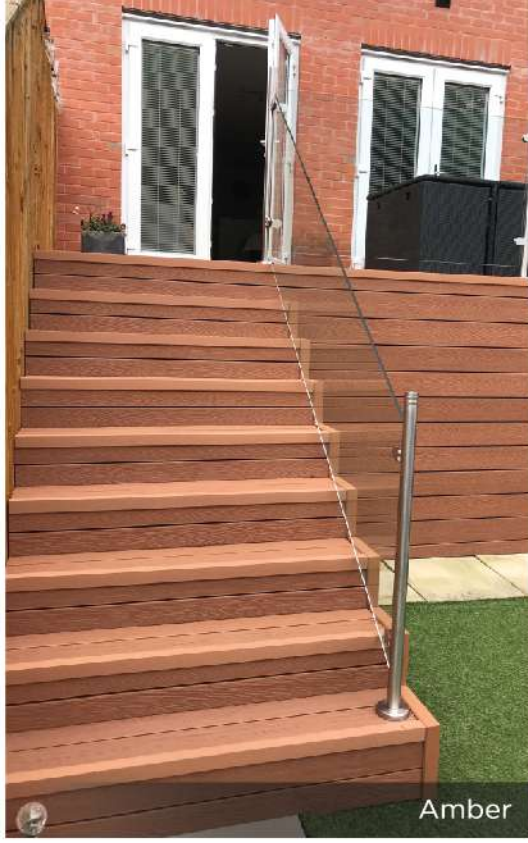

Amber



Ash



Ash



Amber



Stone

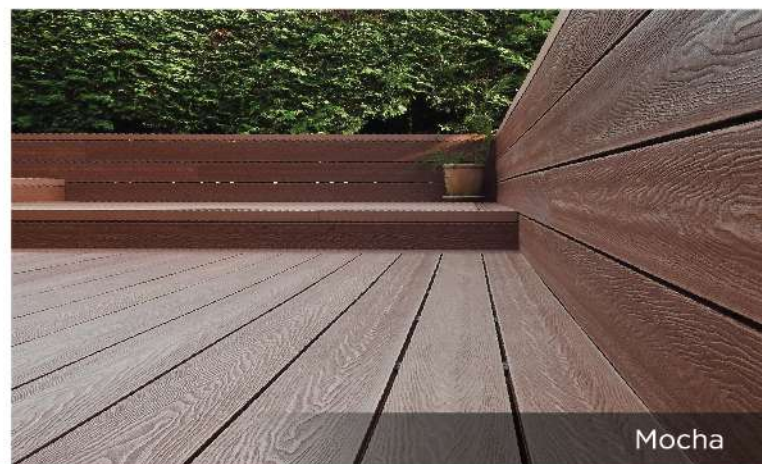

Mocha



Stone & Graphite



Mocha



Ash

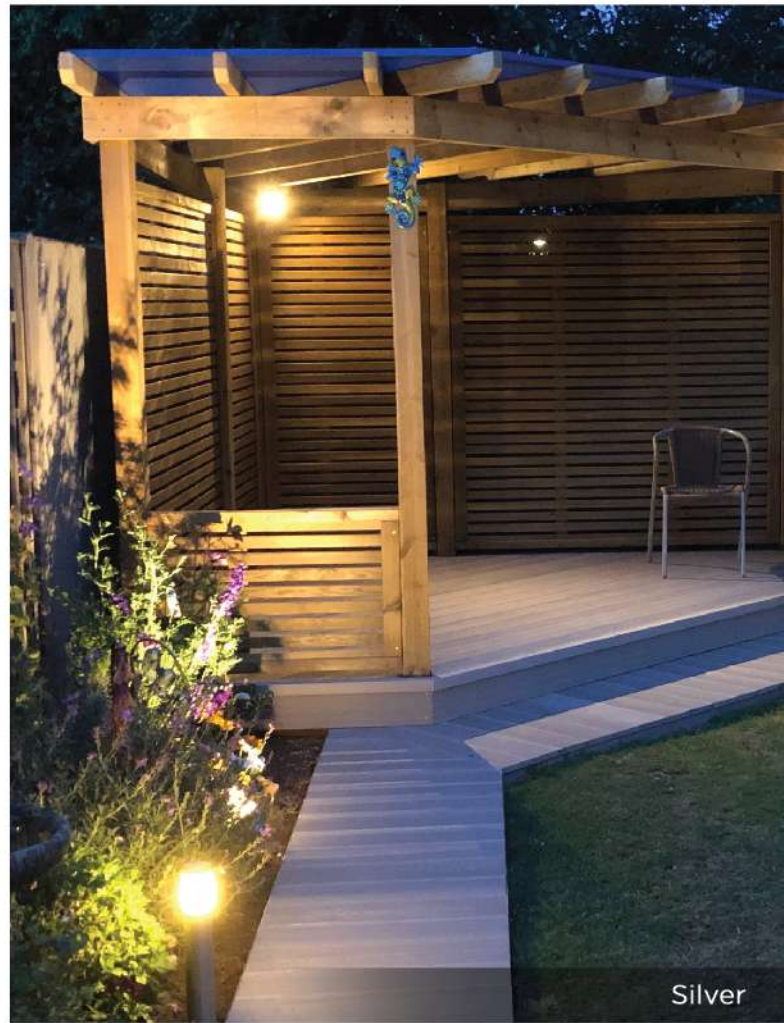

Silver



Stone



Savanna





Silver & Graphite



Ash



Savanna & Cedar



Stone



Ash

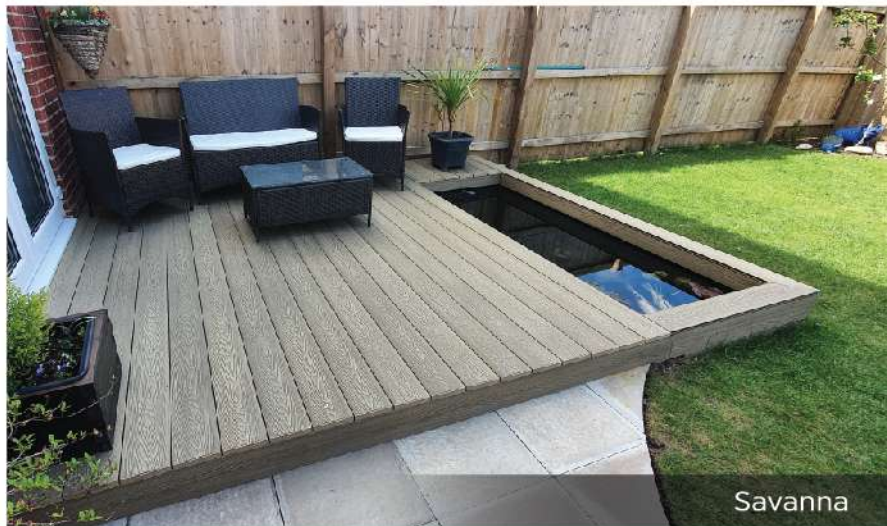

Savanna



Ash



Savanna & Mocha



Amber & Graphite

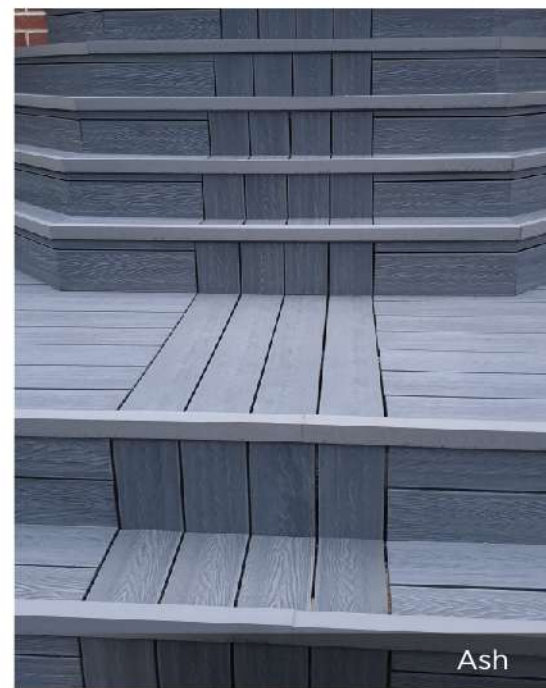

Ash

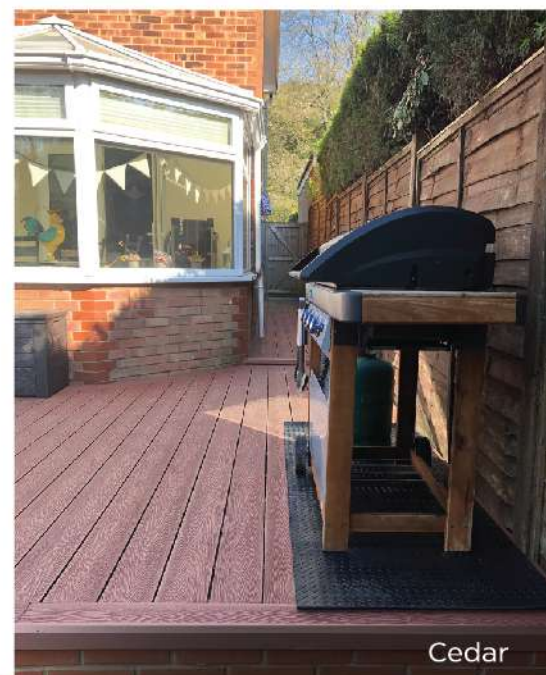

Cedar



Ash & Graphite



Ash & Graphite



Ash & Graphite

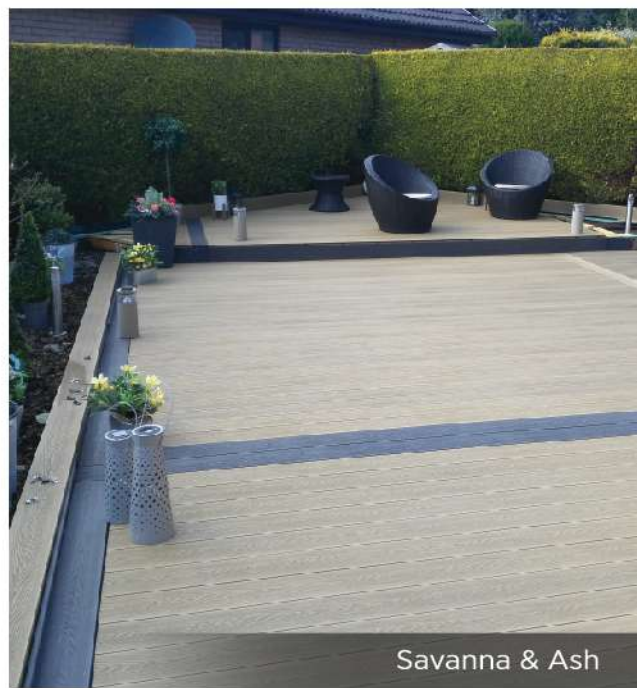

Savanna & Ash

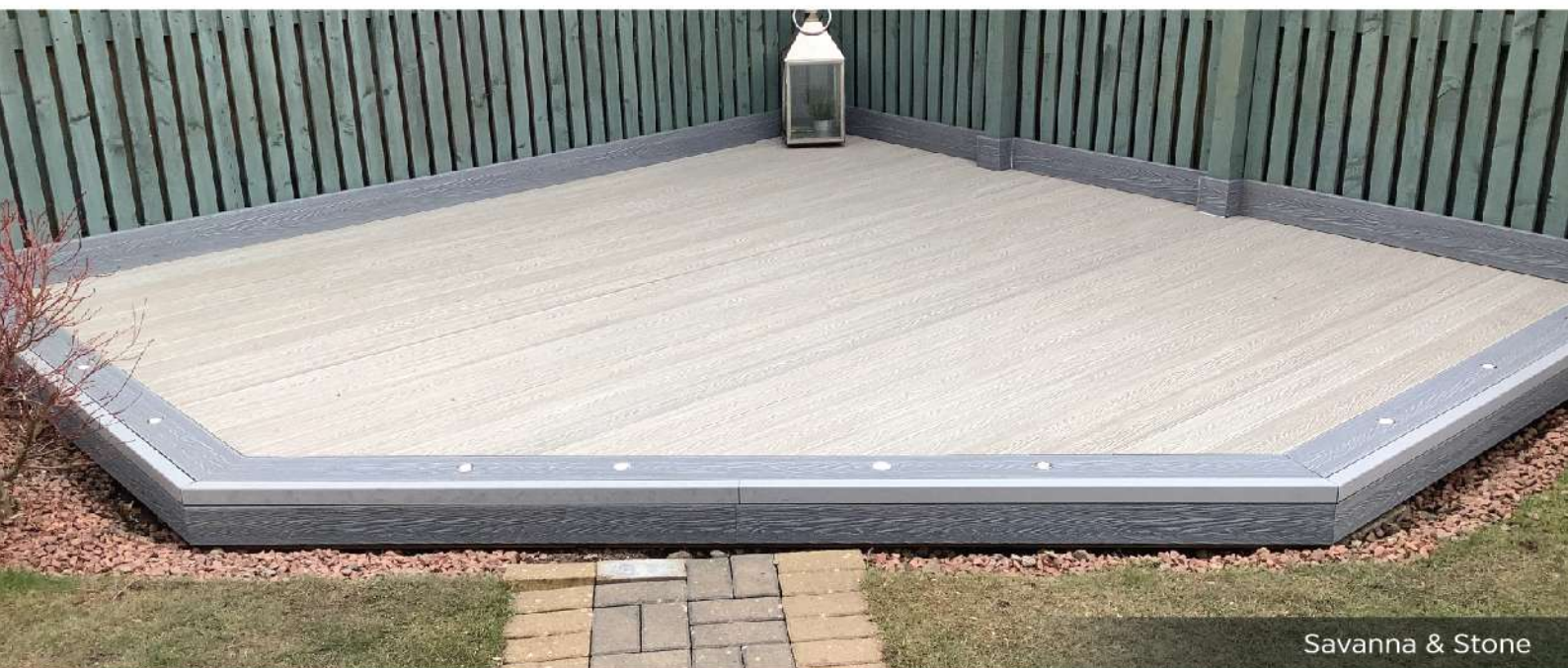

Savanna & Stone



Silver & Mocha



Mocha

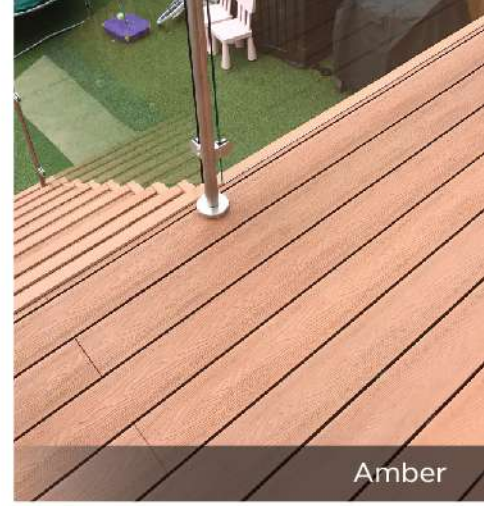

Amber



Ash



Savanna



Ash



Savanna



Amber & Graphite



Silver



Ash



Cedar & Savanna



Savanna



Silver



Silver & Graphite

Price List

Classic Range	Price ex VAT	Price inc VAT	Per
Decking Board 4m (Silver, Ash, Graphite, Savanna, Amber, Cedar, Mocha)	£16.66	£19.99	Length
Decking Board 4m (Stone)	£18.74	£22.49	Length
Decking Board 2.4m (Silver, Ash, Graphite, Savanna, Amber, Cedar, Mocha)	£9.99	£11.99	Length
Decking Board 2.4m (Stone)	£11.24	£13.49	Length
Railing Kit (All Colours)	£41.66	£49.99	Piece
Single Balustrade Post (All Colours)	£41.66	£49.99	Piece
Bullnose Edge 2.2m (All Colours)	£12.49	£14.99	Length
Skirting Board 2.2m (All Colours)	£8.33	£9.99	Length
Edging Trim 2.2m (All Colours)	£6.66	£7.99	Length
End Caps (All Colours)	£0.60	£0.72	Piece

Premium Range	Price ex VAT	Price inc VAT	Per
Decking Board 4m (All Colours)	£24.99	£29.99	Length
Decking Board 2.4m (All Colours)	£14.99	£17.99	Length
Bullnose Edge 2.2m (All Colours)	£14.16	£16.99	Length
Skirting Board 2.2m (All Colours)	£9.16	£10.99	Length
Edging Trim 2.2m (All Colours)	£7.49	£8.99	Length
End Caps (All Colours)	£0.83	£0.99	Piece

Fastening System	Price ex VAT	Price inc VAT	Per
6mm Hidden Fasteners (Screws Included)	£16.66	£19.99	100
3mm Hidden Fasteners (Screws Included)	£24.99	£29.99	100
Starter Hidden Fasteners (Screws Included)	£22.49	£26.99	100
Additional Screws (6mm & Starter Compatible)	£8.33	£9.99	100
Additional Screws (3mm Compatible)	£8.33	£9.99	100
Torx T15 Screw Bit	£2.49	£2.99	Piece

Cladding	Price ex VAT	Price inc VAT	Per
Cladding Board 4m (All Colours)	£16.66	£19.99	Length
Edging Trim 2.2m (All Colours)	£7.49	£8.99	Length
Cladding Hidden Fasteners (Screws Included)	£24.99	£29.99	100
Additional Screws (Cladding Fastener Compatible)	£8.33	£9.99	100

Substructure

Substructure	Price ex VAT	Price inc VAT	Per
Aluminium Joist 3.6m	£16.66	£19.99	Length
Composite Batten 3m	£6.66	£7.99	Length
Pedestal 15mm	£1.92	£2.30	Piece
Pedestal 23-28mm	£2.92	£3.50	Piece
Pedestal 28-35mm	£3.00	£3.60	Piece
Pedestal 48-75mm	£3.25	£3.90	Piece
Pedestal 75-100mm	£3.58	£4.30	Piece
Pedestal 100-128mm	£3.75	£4.50	Piece
Pedestal 137-165mm	£4.38	£5.25	Piece
Pedestal 165-265mm	£5.00	£6.00	Piece
Pedestal 265-365mm	£6.04	£7.25	Piece
Pedestal 365-528mm	£7.08	£8.50	Piece
Slope Corrector	£1.66	£1.99	Piece
Rubber Mat	£0.83	£0.99	Piece



Product Showroom

Dino Decking Ltd
Unit 1 Wetheral Close
Hindley Industrial Estate
Hindley Green
Wigan
WN2 4HS



dino
DECKING

Dino Decking Ltd
Unit 1 Wetheral Close
Hindley Industrial Estate
Hindley Green
Wigan
WN2 4HS

Company Registration Number: 10837233
VAT Number: GB296097848